

PbS, PbSe near-infrared detector

TE-cooled Single-Pixel double encapsulated TO8-package

Features

- Double encapsulation (thin-film + TO8 package)
- One or Two-Stage thermoelectric cooler (TEC)
- High durability for rugged operation
- Very high sensitivity
- Sapphire window
- Custom windows and filters available

Applications

- Flame monitoring
- Flame and spark detection
- Gas detection and analysis
- Spectroscopy
- Temperature measurement
- Moisture measurement

Overview PbS detectors with TEC

	Type No.	Dimensional outline	Cooling	Active area [mm x mm]	Replaces following Hamamatsu detector
PbS	PbS050040TO8-1TEC	Type 1	One-stage TE-cooled	4x5	P2532-01
	PbS050040TO8-2TEC	Type 2	Two-stage TE-cooled		P2682-01
	PbS050050TO8-1TEC	Type 1	One-stage TE-cooled	5x5	
	PbS050050TO8-2TEC	Type 2	Two-stage TE-cooled		
PbSe	PbSe020020TO8-1TEC	Type 1	One-stage TE-cooled	2x2	P9696-102
	PbSe020020TO8-2TEC	Type 2	Two-stage TE-cooled		P2038-02
					P9696-202
	PbSe030030TO8-1TEC	Type 1	One-stage TE-cooled	3x3	P2680-02
	PbSe030030TO8-2TEC	Type 2	Two-stage TE-cooled		P9696-103
					P2038-03
				P9696-203	
				P2680-03	

Storage

- Storage temperature: -55°C to +70°C
- Exposure to UV light results in permanent damage
- Prolonged exposure to visible light results in temporary low dark resistance

Handling

- Ensure dust-free environment for device handling
- Operating temperature: -30°C to +70°C

PbS, PbSe near-infrared detector

TE-cooled Single-Pixel double encapsulated TO8-package

Type 1 exemplary package outlines (mm)

PbS050040TO8-1TEC

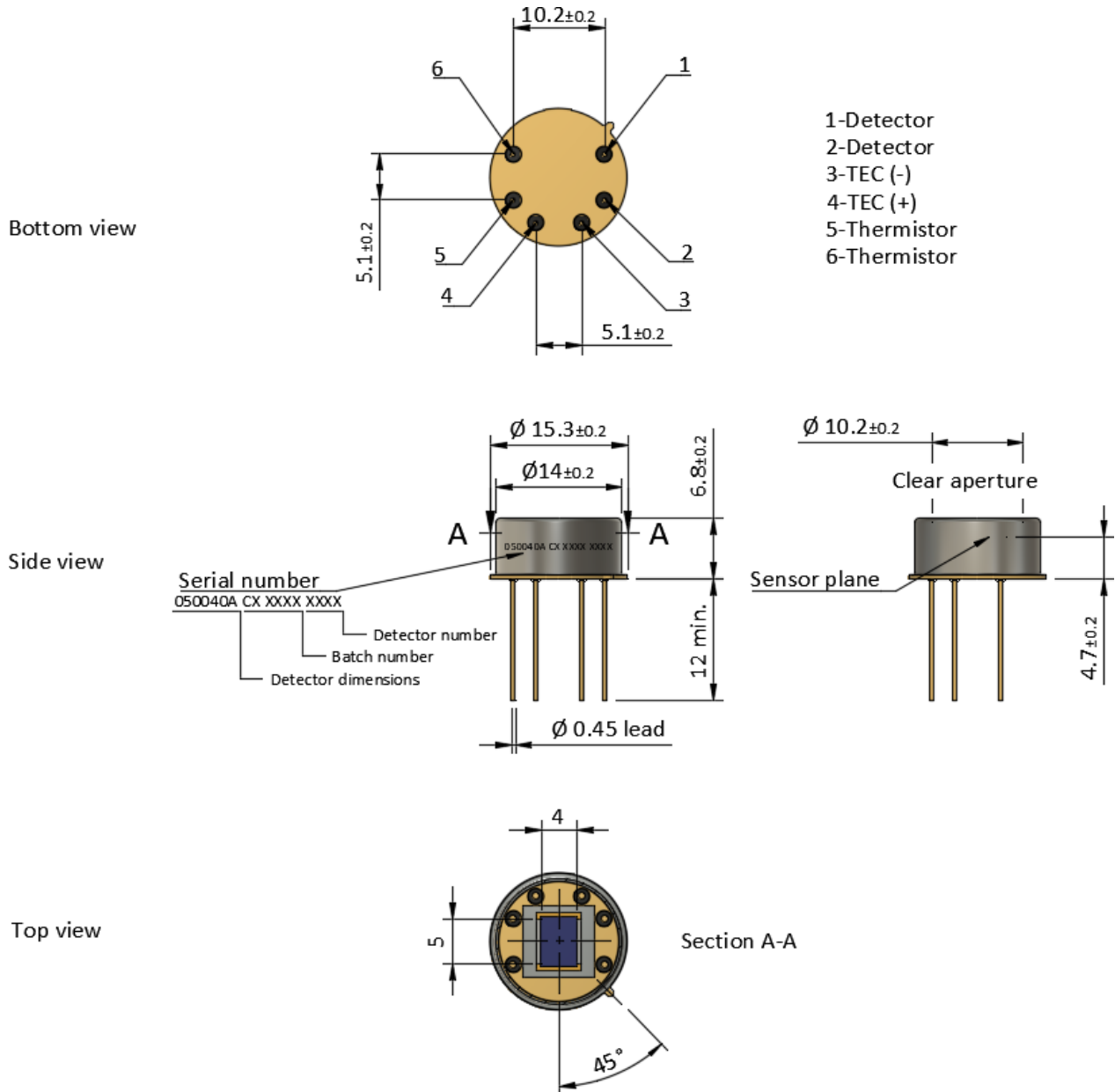

PbS, PbSe near-infrared detector

TE-cooled Single-Pixel double encapsulated TO8-package

Type 2 exemplary package outlines (mm)

PbS050050TO8-2TEC

Bottom view

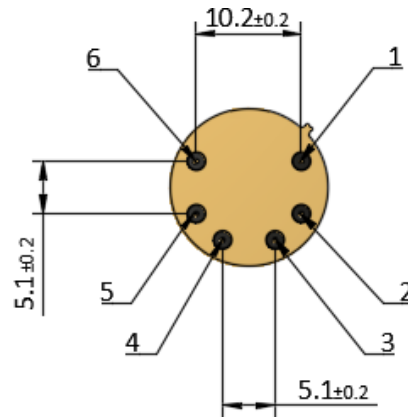

- 1-Detector
- 2-Detector
- 3-TEC (-)
- 4-TEC (+)
- 5-Thermistor
- 6-Thermistor

Side view

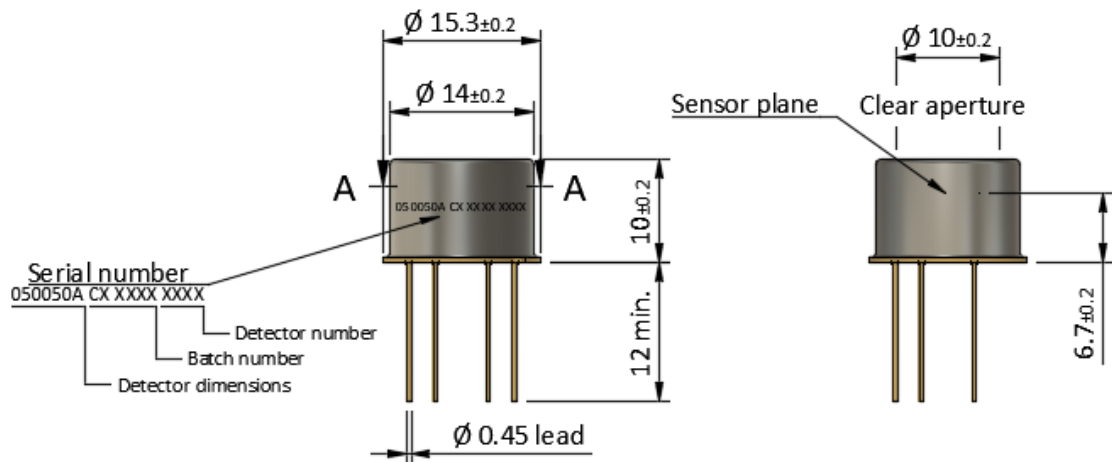

Top view

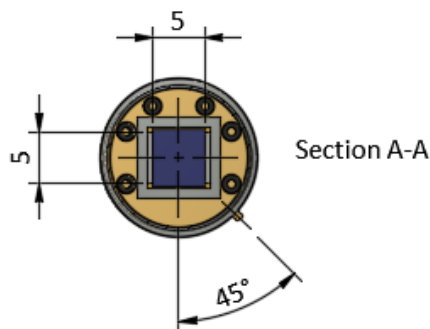

PbS, PbSe near-infrared detector

TE-cooled Single-Pixel double encapsulated TO8-package



A brand of
BASF – We create chemistry

Characteristics thermoelectric cooler (1TEC)

Single stage TEC U-I-curve

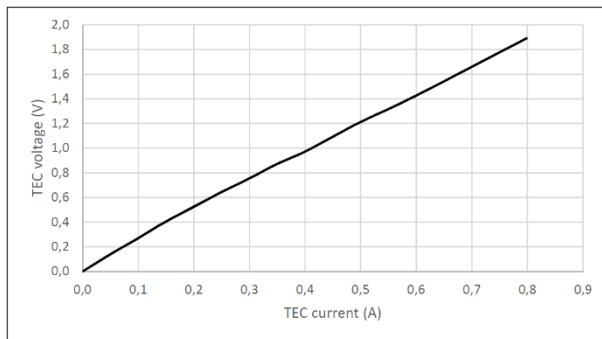

NTC resistance curve

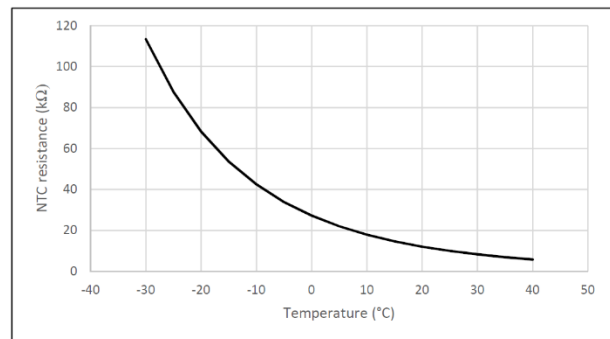

TEC cooling performance (absolute)

Ambient temperature +24°C, heat sink <7 K/W

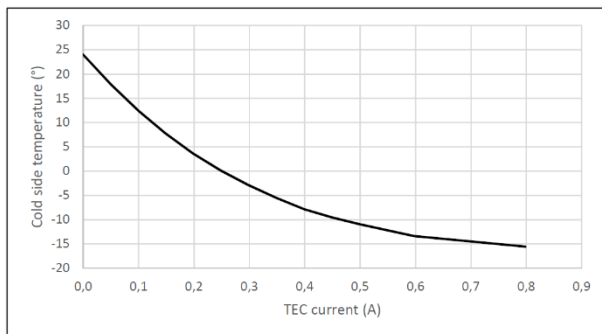

TEC cooling performance (relative)

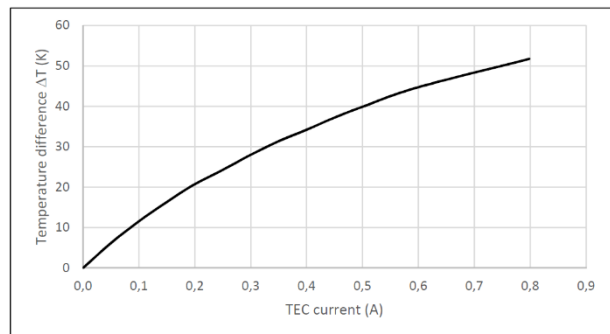

PbS, PbSe near-infrared detector

TE-cooled Single-Pixel double encapsulated TO8-package



A brand of
BASF – We create chemistry

Characteristics thermoelectric cooler (2TEC)

TEC cooling performance (absolute)

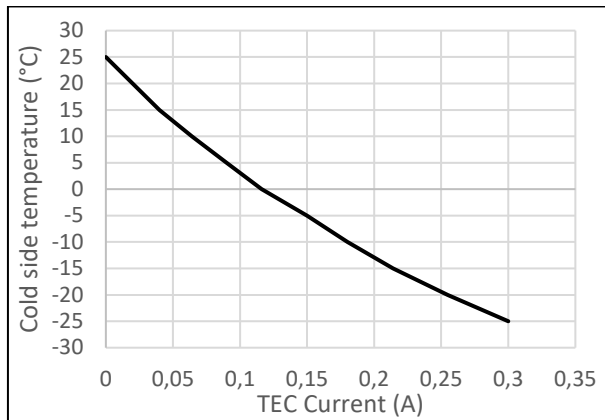

2-stage TEC U-I-curve

Ambient temperature +21°C

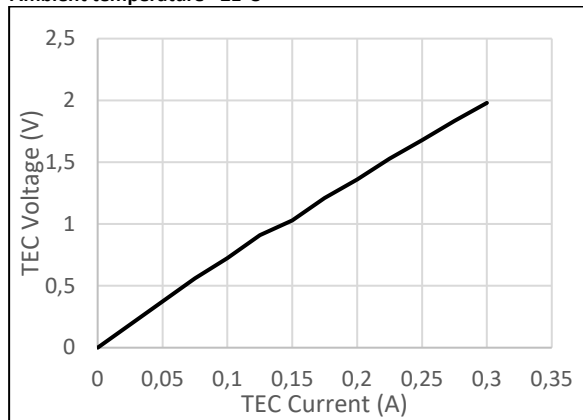

NTC resistance curve

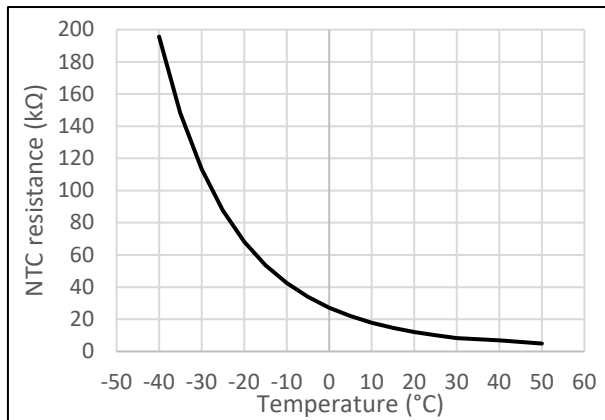

NTC resistance at key temperatures

Temperature (°C)	NTC resistance (Ω)
20	12.081k ±1%
0	27.219k ±1%
-10	42.506k ±1%
-15	53.65k ±1%
-20	68.237k ±1%

Resistance (25°C) (ohm)	B-Constant (25-50°C) (K)	B-Constant (25-80°C) (Reference Value) (K)	B-Constant (25-85°C) (Reference Value) (K)	B-Constant (25-100°C) (Reference Value) (K)	Maximum Operating Current (25°C) (mA)	Maximum Voltage (V)	Typical Dissipation Constant (25°C) (mW/°C)
10k ±1%	3380 ±1%	3428	3434	3455	0.100	5	1

PbS, PbSe near-infrared detector

TE-cooled Single-Pixel double encapsulated TO8-package

trinamiX

A brand of
BASF – We create chemistry

Exemplary readout circuit

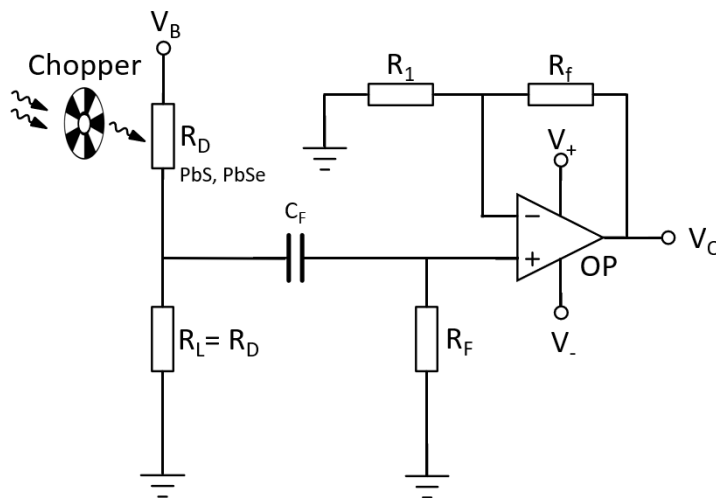

- V_B : Bias voltage
- V_O : Output voltage
- R_D : Dark resistance of the detector
- R_L : Load resistor
- C_F : Filter capacitor
- R_F : Filter resistor
- R_f : Feedback resistor
- R_1 : Gain resistor

Regulatory

For the use of Hertzstück™ PbS and PbSe infrared photodetectors in medical devices, monitoring and control instruments and consumer applications RoHS exemptions apply.

For automotive applications Hertzstück™ PbS and PbSe infrared photodetectors fall under ELV exemption.